

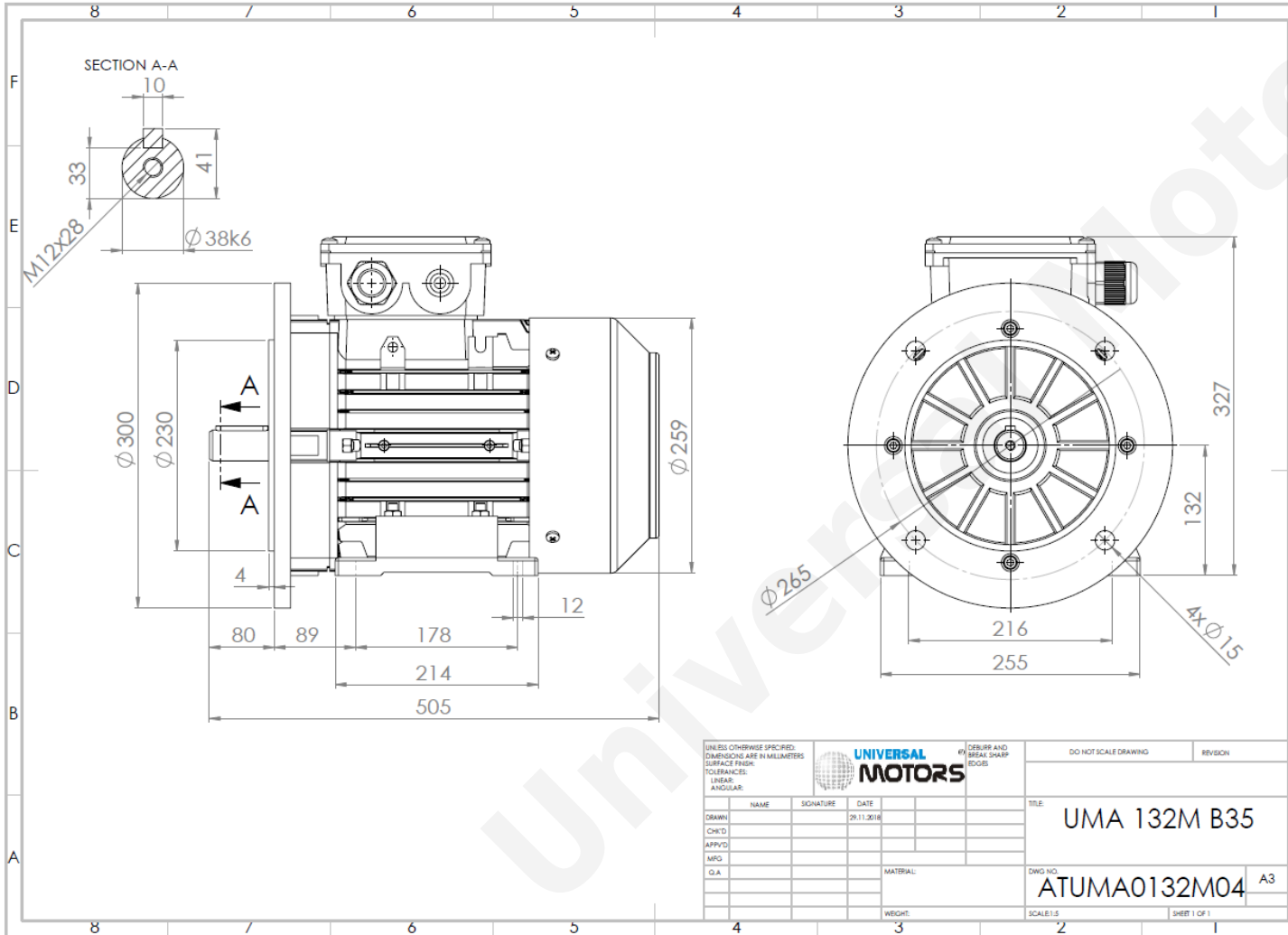

TECHNICAL DATA

Three Phase Electric Motors - Aluminum Frame
 UM3A 132M2-6 IE3
 5.5 kW / 7.5 Cv
 975 RPM



Motor type:	UM3A 132M2-6 IE3
Output:	5.5 kW / 7.5 Cv
Speed (min ⁻¹):	975 RPM
Frequency:	50 Hz
Voltage:	400 V
Current:	12.70 A
Power factor (Cos Ø):	0.71
Poles:	6
Insulation class:	F
Temperature rise Class:	B
Efficiency 50%:	87.1 %
Efficiency 75%:	88.3 %
Efficiency 100%:	88.0 %
Torque:	55 N.m
Tstarting/Tnominal:	2.9
Istarting/Inominal:	7.4
Tmaximum/Tnominal:	3.5
Noise:	68 Db(A)
Weight:	55.7 Kg
Brake AC:	AC7
Torque Brake DC:	80 N.m
Bearing DE:	6308 2Z
Bearing NDE:	6208 2Z
Torque Brake AC:	90 N.m
Brake DC:	REB-05-16

Regime - S1

Altitude - 1000m

Environment Temperature - 40°C

CONTACTS:

UNIVERSAL MOTORS Tel: +351 252 299 080
 Rua de São Brás,745 Fax: +351 252 299 089
 4480-782 VILA DO CONDE Mail: geral@universalmotors.pt

* References applied only in the UK